

ROLLWALZTECHNIK
ABELE + HÖLTICH GMBH



Rändelwerkzeuge / *Knurling Tools*

ROLLWALZTECHNIK fertigt Rändelräder und Rändelwerkzeuge für alle denkbaren Einsatzzwecke. Konische, konvexe und konkave Werkzeuge sowie Rollen für alle Rollkopfsysteme sind lieferbar.

Sämtliche Rollköpfe und Rändelhalter werden mit hoher Präzision gefertigt, die Profilierung unserer Rändelräder ist feingefräst. Auf Wunsch liefern wir die Rändelwerkzeuge auch mit geläpftem Profil, welches sich besonders für adhäsive bzw. „schmierende“ Werkstoffe eignet, einen optisch höherwertigen Rändel und eine längere Standzeit des Einsatzwerkzeuges ermöglicht.

Der hochwertige HSS-Stahl unserer Rändelwerkzeuge wird in einem Vakuumverfahren gehärtet, sämtliche Bohrungen und Planflächen sind geschliffen.

Für die Bearbeitung von VA und hochfesten Stählen bieten wir auch Rändelräder in diversen HSS-Co Qualitäten an. Ein Spezialnitrierverfahren sorgt bei diesen anspruchsvollen Einsätzen für hohe Standzeiten.

Standardmäßig werden alle **Rändelräder mit einer 45° Fase** geliefert. Unser Lieferprogramm umfasst auch diverse Rändelräder und -halter in **Zollabmessungen**, gerne erteilen wir ihnen diesbezüglich jederzeit Auskunft.

***ROLLWALZTECHNIK** is producing knurling wheels and tools for all imaginable requirements. Conical, convex and concave dies for many holder types and also rolls for nearly all rolling heads are available.*

All rolling heads and knurling holders are manufactured to highest standard of quality, all the profiles of our knurling wheels are fine milled. If necessary we deliver our knurling dies also with a lapped profile, recommended for adhesive and smearing materials, a high finish and a long tool life.

A high quality grade of high speed steel is our standard material, which is vacuum hardened and tempered. Surfaces and bores are all ground.

For processing stainless and high-tensile steels we also offer knurling wheels in variant Hi-Cobalt qualities such as M42. For these ambitious requirements a special nitration treatment guarantees a long tool life.

*By standard are **all knurling wheels are delivered with 45° chamfers** and our product range also includes several knurling wheels and holders in **inch-dimensions**.*

ROLLWALZTECHNIK Abele + Höltich GmbH
Jahnstraße 33–35, D-78234 Engen
Telefon: +49-(0) 77 33-94 41-0, Fax: +49-(0) 77 33-94 41-20
E-Mail: info@rollwalztechnik.de, Web: www.rollwalztechnik.de

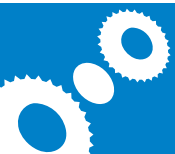

Inhaltsverzeichnis / *Directory*

Das Rändelumformverfahren / <i>The form-knurling process</i>	4
Rändelräder nach DIN 403 / <i>Knurling wheels according to DIN 403</i>	4
Bundrändelräder / <i>Knurling wheels for up to a shoulder use</i>	8
Konvexe Rändelräder / <i>Convex knurling wheels</i>	9
Das Fräsrändelverfahren / <i>The cut knurling process</i>	10
Fräsrändelräder / <i>Cut knurling wheels with lapped tooth profile</i>	10
Rändelhalter „Standard“ / <i>Knurl holder “Standard”</i>	12
Rändelhalter „RGE“ / <i>Knurl holder “RGE”</i>	13
Rändelhalter „Modular“ / <i>Knurl holder “Modular”</i>	14
„Modular“ Komponenten / <i>“Modular” components</i>	15
Rändelhalter „Selbstzentrierend RGE“ <i>Knurl holder “Self Centering RGE”</i>	16
Rändelhalter „Bund-Standard“ <i>Knurl holder “Shoulder-Standard”</i>	17
Rändelhalter „Bund-RGE“ / <i>Knurl holder “Shoulder-RGE”</i>	18
Rändelhalter „Bund-Schwer-Standard“ <i>Knurl holder “Shoulder-Heavy-Standard”</i>	19
Rändelhalter „Bund-Schwer-RGE“ <i>Knurl holder “Shoulder-Heavy-RGE”</i>	20
Rändelhalter „Schwenkbar“ / <i>Knurl holder “Swiveling”</i>	21
Rändelhalter „Schwenkbar-Schwer“ <i>Knurl holder “Swiveling-Heavy-Duty”</i>	22
Fräsrändelhalter „RGE-VDI“ / <i>Cut-knurl holder “RGE-VDI”</i>	23
Fräsrändelhalter „RAA“ / <i>Cut-knurl holder “RAA”</i>	24
Fräsrändelhalter „RGE“ / <i>Cut-knurl holder “RGE”</i>	26
Stirnrändelhalter „Starr“ und „Einstellbar“ <i>Face-knurl holder “Fixed” and “Adjustable”</i>	28
Stirnrändeleinsätze / <i>Face-knurling dies</i>	29
Rändelhalter „Bohrung“ / <i>Internal holder “Bore”</i>	30
Rändelhalter „Konisch“ / <i>Knurl holder “Conical”</i>	32
Rändelkopf / <i>Knurling-head</i>	33
Vorschubgeschwindigkeiten beim Rändelumformverfahren <i>Feed and speed charts for form knurling</i>	34
Schnitt- und Vorschubgeschwindigkeiten beim Rändelfräsen <i>Feed and speed charts for cut knurling</i>	35

Das Rändelumformverfahren









The form-knurling process

Bei der spanlosen Herstellung von Rändeln findet eine Kaltumformung der Werkstückoberfläche statt, was eine Formbarkeit des Werkstoffes voraussetzt. Durch die Verdrängung des Materiales wird der Außendurchmesser vergrößert, gleichzeitig findet eine Verdichtung der Oberfläche statt. Die vielseitige Anwendbarkeit des Rändelumformverfahrens erlaubt die Herstellung aller Rändelprofile bis zum Bund, das Rändelwerkzeug kann an jeder Stelle des Werkstückes angesetzt werden. Auch ermöglicht diese Technik Innenrändelungen, Stirnrändelungen und konische Rändelungen.









The chipless form knurling is a cold forming process on the workpiece surface that requires a plasticity of the material. Depending on material and pitch of the knurl the compressed and displaced material of the surface increases and the diameter of the workpiece. The versatile applicability of form knurling allows the production of all knurls up to a shoulder and the tool can be inserted on any desired point at the workpiece. This method also enables bore-, face- and conical knurlings.

Rändelräder nach DIN 403

Knurling wheels according to DIN 403

Rändelrad knurling wheel Type in mm	Teilung Pitch in mm	Bestell-Nr. Order-No. AA 	Bestell-Nr. Order-No. BR 30° 	Bestell-Nr. Order-No. BL 30° 	Bestell-Nr. Order-No. BR 45° 	Bestell-Nr. Order-No. BL 45° 	Bestell-Nr. Order-No. GE 30° M 	Bestell-Nr. Order-No. GV 30° F 	Bestell-Nr. Order-No. GE 45° M 	Bestell-Nr. Order-No. GV 45° F 
MB 10 x 3 x 4	0.3	MBSX-0.3	-	-	MBDX-0.3	MBCX-0.3	-	-	-	MBGX-0.3
	0.4	MBSX-0.4	-	-	MBDX-0.4	MBCX-0.4	-	-	-	MBGX-0.4
	0.5	MBSX-0.5	-	-	MBDX-0.5	MBCX-0.5	-	-	-	MBGX-0.5
	0.6	MBSX-0.6	-	-	MBDX-0.6	MBCX-0.6	-	-	-	MBGX-0.6
	0.7	MBSX-0.7	-	-	MBDX-0.7	MBCX-0.7	-	-	-	MBGX-0.7
	0.8	MBSX-0.8	-	-	MBDX-0.8	MBCX-0.8	-	-	-	MBGX-0.8
	0.9	MBSX-0.9	-	-	-	-	-	-	-	MBGX-0.9
	1.0	MBSX-1.0	-	-	MBDX-1.0	MBCX-1.0	-	-	-	MBGX-1.0

Ausschließlich in HSS-Co lieferbar / Only in Hi-Cobalt available

Rändelrad knurling wheel Type in mm	Teilung Pitch in mm	Bestell-Nr. Order-No. AA 	Bestell-Nr. Order-No. BR 30° 	Bestell-Nr. Order-No. BL 30° 	Bestell-Nr. Order-No. BR 45° 	Bestell-Nr. Order-No. BL 45° 	Bestell-Nr. Order-No. GE 30° M 	Bestell-Nr. Order-No. GV 30° F 	Bestell-Nr. Order-No. GE 45° M 	Bestell-Nr. Order-No. GV 45° F 
MM 10 × 4 × 4	0.2	MMS-0.2	-	-	-	-	-	-	-	-
	0.3	MMS-0.3	MMR-0.3	MML-0.3	MMD-0.3	MMC-0.3	MMM-0.3	MMF-0.3	MMN-0.3	MMG-0.3
	0.4	MMS-0.4	MMR-0.4	MML-0.4	MMD-0.4	MMC-0.4	MMM-0.4	MMF-0.4	MMN-0.4	MMG-0.4
	0.5	MMS-0.5	MMR-0.5	MML-0.5	MMD-0.5	MMC-0.5	MMM-0.5	MMF-0.5	MMN-0.5	MMG-0.5
	0.6	MMS-0.6	MMR-0.6	MML-0.6	MMD-0.6	MMC-0.6	MMM-0.6	MMF-0.6	MMN-0.6	MMG-0.6
	0.7	MMS-0.7	MMR-0.7	MML-0.7	MMD-0.7	MMC-0.7	MMM-0.7	MMF-0.7	MMN-0.7	MMG-0.7
	0.8	MMS-0.8	MMR-0.8	MML-0.8	MMD-0.8	MMC-0.8	MMM-0.8	MMF-0.8	MMN-0.8	MMG-0.8
	0.9	MMS-0.9	MMR-0.9	MML-0.9	MMD-0.9	MMC-0.9	MMM-0.9	MMF-0.9	MMN-0.9	MMG-0.9
	1.0	MMS-1.0	MMR-1.0	MML-1.0	MMD-1.0	MMC-1.0	MMM-1.0	MMF-1.0	MMN-1.0	MMG-1.0
	1.2	MMS-1.2	MMR-1.2	MML-1.2	MMD-1.2	MMC-1.2	MMM-1.2	MMF-1.2	MMN-1.2	MMG-1.2
	1.5	MMS-1.5	MMR-1.5	MML-1.5	MMD-1.5	MMC-1.5	MMM-1.5	MMF-1.5	MMN-1.5	MMG-1.5

Nahezu alle Abmessungen sind auch in HSS-Co lieferbar / Nearly all dimensions are also available in Hi-Cobalt

MN 15 × 4 × 4	0.3	MNS-0.3	MNR-0.3	MNL-0.3	MND-0.3	MNC-0.3	-	-	-	MNG-0.3
	0.4	MNS-0.4	MNR-0.4	MNL-0.4	MND-0.4	MNC-0.4	-	-	-	MNG-0.4
	0.5	MNS-0.5	MNR-0.5	MNL-0.5	MND-0.5	MNC-0.5	-	-	-	MNG-0.5
	0.6	MNS-0.6	MNR-0.6	MNL-0.6	MND-0.6	MNC-0.6	-	-	-	MNG-0.6
	0.7	MNS-0.7	MNR-0.7	MNL-0.7	MND-0.7	MNC-0.7	-	-	-	MNG-0.7
	0.8	MNS-0.8	MNR-0.8	MNL-0.8	MND-0.8	MNC-0.8	-	-	-	MNG-0.8
	0.9	MNS-0.9	MNR-0.9	MNL-0.9	MND-0.9	MNC-0.9	-	-	-	MNG-0.9
	1.0	MNS-1.0	MNR-1.0	MNL-1.0	MND-1.0	MNC-1.0	-	-	-	MNG-1.0
	1.2	MNS-1.2	MNR-1.2	MNL-1.2	MND-1.2	MNC-1.2	-	-	-	MNG-1.2
	1.5	MNS-1.5	MNR-1.5	MNL-1.5	MND-1.5	MNC-1.5	-	-	-	MNG-1.5

Einige Abmessungen sind auch in HSS-Co lieferbar / Some dimensions are also available in Hi-Cobalt









MQ 15 × 6 × 4	0.3	MQS-0.3	MQR-0.3	MQL-0.3	MQD-0.3	MQC-0.3	MQM-0.3	MQF-0.3	MQN-0.3	MQG-0.3
	0.4	MQS-0.4	MQR-0.4	MQL-0.4	MQD-0.4	MQC-0.4	MQM-0.4	MQF-0.4	MQN-0.4	MQG-0.4
	0.5	MQS-0.5	MQR-0.5	MQL-0.5	MQD-0.5	MQC-0.5	MQM-0.5	MQF-0.5	MQN-0.5	MQG-0.5
	0.6	MQS-0.6	MQR-0.6	MQL-0.6	MQD-0.6	MQC-0.6	MQM-0.6	MQF-0.6	MQN-0.6	MQG-0.6
	0,7	MQS-0.7	MQR-0.7	MQL-0.7	MQD-0.7	MQC-0.7	MQM-0.7	MQF-0.7	MQN-0.7	MQG-0.7
	0.8	MQS-0.8	MQR-0.8	MQL-0.8	MQD-0.8	MQC-0.8	MQM-0.8	MQF-0.8	MQN-0.8	MQG-0.8
	0.9	MQS-0.9	MQR-0.9	MQL-0.9	MQD-0.9	MQC-0.9	MQM-0.9	MQF-0.9	MQN-0.9	MQG-0.9
	1,0	MQS-1.0	MQR-1.0	MQL-1.0	MQD-1.0	MQC-1.0	MQM-1.0	MQF-1.0	MQN-1.0	MQG-1.0
	1,2	MQS-1.2	MQR-1.2	MQL-1.2	MQD-1.2	MQC-1.2	MQM-1.2	MQF-1.2	MQN-1.2	MQG-1.2
	1.5	MQS-1.5	MQR-1.5	MQL-1.5	MQD-1.5	MQC-1.5	MQM-1.5	MQF-1.5	-	MQG-1.5
	2.0	MQS-2.0	MQR-2.0	MQL-2.0	MQD-2.0	MQC-2.0	-	-	MQN-2.0	-

Nahezu alle Abmessungen sind auch in HSS-Co lieferbar / Nearly all dimensions are also available in Hi-Cobalt

Zollabmessungen in diversen Stahlqualitäten sind ebenfalls lieferbar
Inch dimensions are also available in different steel qualities

Rändelräder nach DIN 403









Knurling wheels according to DIN 403

Rändelrad knurling wheel Type in mm	Teilung Pitch in mm	Bestell-Nr. Order-No. AA 	Bestell-Nr. Order-No. BR 30° 	Bestell-Nr. Order-No. BL 30° 	Bestell-Nr. Order-No. BR 45° 	Bestell-Nr. Order-No. BL 45° 	Bestell-Nr. Order-No. GE 30° M 	Bestell-Nr. Order-No. GV 30° F 	Bestell-Nr. Order-No. GE 45° M 	Bestell-Nr. Order-No. GV 45° F 
MR 20 × 6 × 6	0.4	MRS-0.4	MRR-0.4	MRL-0.4						
	0.5	MRS-0.5	MMR-0.5	MRL-0.5						
	0.6	MRS-0.6	MRR-0.6	MRL-0.6						
	0.7	MRS-0.7	-	-						
	0.8	MRS-0.8	MMR-0.8	MRL-0.8						
	0.9	MRS-0.9	-	-	-	-	-	-	-	-
	1.0	MRS-1.0	MRR-1.0	MRL-1.0	-	-	-	-	-	-
	1.2	MRS-1.2	MRR-1.2	MRL-1.2	-	-	-	-	-	MRG-1.2
	1.3	MRS-1.3	-	-	-	-	-	-	-	-
	1.4	MRS-1.4	-	-	-	-	-	-	-	-
	1.5	MRS-1.5	MRR-1.5	MRL-1.5	MRD-1.5	MRC-1.5	-	-	-	-
	1.6	MRS-1.6	-	-	-	-	-	-	-	-
2.0	MRS-2.0	MRR-2.0	MRL-2.0	-	-	-	-	-	-	

Einige Abmessungen auch in HSS-Co lieferbar / Some dimensions are also available in Hi-Cobalt

MS 20 × 8 × 6	0.3	MSS-0.3	MSR-0.3	MSL-0.3	MSD-0.3	MSC-0.3	MSM-0.3	MSF-0.3	MSN-0.3	-
	0.4	MSS-0.4	MSR-0.4	MSL-0.4	MSD-0.4	MSC-0.4	MSM-0.4	MSF-0.4	MSN-0.4	-
	0.5	MSS-0.5	MSR-0.5	MSL-0.5	MSD-0.5	MSC-0.5	MSM-0.5	MSF-0.5	MSN-0.5	MSG-0.5
	0.6	MSS-0.6	MSR-0.6	MSL-0.6	MSD-0.6	MSC-0.6	MSM-0.6	MSF-0.6	MSN-0.6	MSG-0.6
	0.7	MSS-0.7	MSR-0.7	MSL-0.7	MSD-0.7	MSC-0.7	MSM-0.7	MSF-0.7	MSN-0.7	MSG-0.7
	0.8	MSS-0.8	MSR-0.8	MSL-0.8	MSD-0.8	MSC-0.8	MSM-0.8	MSF-0.8	MSN-0.8	MSG-0.8
	0.9	MSS-0.9	MSR-0.9	MSL-0.9	MSD-0.9	MSC-0.9	MSM-0.9	MSF-0.9	MSN-0.9	MSG-0.9
	1.0	MSS-1.0	MSR-1.0	MSL-1.0	MSD-1.0	MSC-1.0	MSM-1.0	MSF-1.0	MSN-1.0	MSG-1.0
	1.2	MSS-1.2	MSR-1.2	MSL-1.2	MSD-1.2	MSC-1.2	MSM-1.2	MSF-1.2	MSN-1.2	MSG-1.2
	1,5	MSS-1.5	MSR-1.5	MSL-1.5	MSD-1.5	MSC-1.5	MSM-1.5	MSF-1.5	MSN-1.5	MSG-1.5
	1,6	MSS-1.6	-	-	-	-	-	-	-	-
	2,0	MSS-2.0	MSR-2.0	MSL-2.0	MSD-2.0	MSC-2.0	MSM-2.0	MSF-2.0	MSN-2.0	MSG-2.0
	2,5	MSS-2.5	MSR-2.5	MSL-2.5	MSD-2.5	MSC-2.5	-	-	-	-
	3,0	MSS-3.0	MSR-3.0	MSL-3.0	MSD-3.0	MSC-3.0	-	-	-	-

Nahezu alle Abmessungen sind auch in HSS-Co lieferbar / Nearly all dimensions are also available in Hi-Cobalt

Rändelrad knurling wheel Type in mm	Teilung Pitch in mm	Bestell-Nr. Order-No. AA 	Bestell-Nr. Order-No. BR 30° 	Bestell-Nr. Order-No. BL 30° 	Bestell-Nr. Order-No. BR 45° 	Bestell-Nr. Order-No. BL 45° 	Bestell-Nr. Order-No. GE 30° M 	Bestell-Nr. Order-No. GV 30° F 	Bestell-Nr. Order-No. GE 45° M 	Bestell-Nr. Order-No. GV 45° F 
MU 20 x 10 x 6	0.3	MUSX-0.3	MURX-0.3	MULX-0.3	MUDX-0.3	MUCX-0.3	MUMX-0.3	MUFX-0.3	MUNX-0.3	MUGX-0.3
	0.4	MUSX-0.4	MURX-0.4	MULX-0.4	MUDX-0.4	MUCX-0.4	MUMX-0.4	MUFX-0.4	MUNX-0.4	MUGX-0.4
	0.5	MUSX-0.5	MURX-0.5	MULX-0.5	MUDX-0.5	MUCX-0.5	MUMX-0.5	MUFX-0.5	MUNX-0.5	MUGX-0.5
	0.6	MUSX-0.6	MURX-0.6	MULX-0.6	MUDX-0.6	MUCX-0.6	MUMX-0.6	MUFX-0.6	MUNX-0.6	MUGX-0.6
	0.7	MUSX-0.7	MURX-0.7	MULX-0.7	MUDX-0.7	MUCX-0.7	MUMX-0.7	MUFX-0.7	MUNX-0.7	MUGX-0.7
	0.8	MUSX-0.8	MURX-0.8	MULX-0.8	MUDX-0.8	MUCX-0.8	MUMX-0.8	MUFX-0.8	MUNX-0.8	MUGX-0.8
	0.9	MUSX-0.9	MURX-0.9	MULX-0.9	MUDX-0.9	MUCX-0.9	MUMX-0.9	MUFX-0.9	MUNX-0.9	MUGX-0.9
	1.0	MUSX-1.0	MURX-1.0	MULX-1.0	MUDX-1.0	MUCX-1.0	MUMX-1.0	MUFX-1.0	MUNX-1.0	MUGX-1.0
	1.2	MUSX-1.2	MURX-1.2	MULX-1.2	MUDX-1.2	MUCX-1.2	MUMX-1.2	MUFX-1.2	MUNX-1.2	MUGX-1.2
	1.5	MUSX-1.5	MURX-1.5	MULX-1.5	MUDX-1.5	MUCX-1.5	MUMX-1.5	MUFX-1.5	MUNX-1.5	MUGX-1.5
	2,0	MUSX-2.0	MURX-2.0	MULX-2.0	MUDX-2.0	MUCX-2.0	MUMX-2.0	MUFX-2.0	MUNX-2.0	MUGX-2.0

Ausschließlich in HSS-Co lieferbar / Only available in Hi-Cobalt









MW 25 x 8 x 6	0.3	MWS-0.3	MWR-0.3	MWL-0.3	-	-	-	-	-	MWG-0.3
	0.4	MWS-0.4	MWR-0.4	MWL-0.4	-	-	-	-	-	MWG-0.4
	0.5	MWS-0.5	MWR-0.5	MWL-0.5	MWD-0.5	MWC-0.5	-	MWF-0.5	-	MWG-0.5
	0.6	MWS-0.6	MWR-0.6	MWL-0.6	MWD-0.6	MWC-0.6	-	MWF-0.6	-	MWG-0.6
	0.7	-	-	-	-	-	-	MWF-0.7	-	MWG-0.7
	0.8	MWS-0.8	MWR-0.8	MWL-0.8	MWD-0.8	MWC-0.8	MWM-0.8	MWF-0.8	-	MWG-0.8
	0.9	-	-	-	-	-	-	MWF-0.9	-	MWG-0.9
	1.0	MWS-1.0	MWR-1.0	MWL-1.0	-	-	MWM-1.0	MWF-1.0	-	MWG-1.0
	1.2	MWS-1.2	MWR-1.2	MWL-1.2	MWD-1.2	MWC-1.2	MWM-1.2	MWF-1.2	-	MWG-1.2
	1.5	MWS-1.5	MWR-1.5	MWL-1.5	MWD-1.5	MWC-1.5	MWM-1.5	MWF-1.5	-	MWG-1.5
	1,6	MWS-1.6	MWR-1.6	MWL-1.6	-	-	-	-	-	-
	2,0	MWS-2.0	-	-	MWD-2.0	MWC-2.0	MWM-2.0	MWF-2.0	-	MWG-2.0

Ausschließlich in HSS-Co lieferbar / Only available in Hi-Cobalt

Zollabmessungen in diversen Stahlqualitäten sind ebenfalls lieferbar
Inch dimensions are also available in different steel qualities

Bundrändelräder

Knurling wheels for up to a shoulder use

Rändelrad knurling wheel Type in mm	Teilung Pitch in mm	Bestell-Nr. Order-No. AA 	Bestell-Nr. Order-No. BR 30° 	Bestell-Nr. Order-No. BL 30° 	Bestell-Nr. Order-No. BR 45° 	Bestell-Nr. Order-No. BL 45° 	Bestell-Nr. Order-No. GE 30° M 	Bestell-Nr. Order-No. GV 30° F 	Bestell-Nr. Order-No. GE 45° M 	Bestell-Nr. Order-No. GV 45° F 
ML 20 x 8 x 10/12	0.3	MLS-0.3	-	-	-	-	-	MLF-0.3	-	-
	0.5	MLS-0.5	MLR-0.5	MLL-0.5	-	-	-	MLF-0.5	-	-
	0.6	MLS-0.6	MLR-0.6	MLL-0.6	-	-	-	MLF-0.6	-	-
	0.8	MLS-0.8	MLR-0.8	MLL-0.8	-	-	-	MLF-0.8	-	-
	0.9	-	MLR-0.9	MLL-0.9	-	-	-	MLF-0.9	-	-
	1.0	MLS-1.0	MLR-1.0	MLL-1.0	-	-	-	MLF-1.0	-	-
	1.2	MLS-1.2	MLR-1.2	MLL-1.2	-	-	-	MLF-1.2	-	-
	1.6	MLS-1.6	MLR-1.6	MLL-1.6	-	-	-	-	-	-
	1.8	MLS-1.8	MLR-1.8	MLL-1.8	-	-	-	-	-	-
2.0	MLS-2.0	MLR-2.0	MLL-2.0	-	-	-	MLF-2.0	-	-	

Ausschließlich in HSS und geläpft lieferbar / Only available in HSS and smooth milled tooth profile

Mi 15 x 6 x 10/6	0.3	MiS-0.3	MiR-0.3	MiL-0.3	MiD-0.3	MiC-0.3	MiM-0.3	MiF-0.3	MiN-0.3	MiG-0.3
	0.4	MiS-0.4	MiR-0.4	MiL-0.4	MiD-0.4	MiC-0.4	MiM-0.4	MiF-0.4	MiN-0.4	MiG-0.4
	0.5	MiS-0.5	MiR-0.5	MiL-0.5	MiD-0.5	MiC-0.5	MiM-0.5	MiF-0.5	MiN-0.5	MiG-0.5
	0.6	MiS-0.6	MiR-0.6	MiL-0.6	MiD-0.6	MiC-0.6	MiM-0.6	MiF-0.6	MiN-0.6	MiG-0.6
	0.7	MiS-0.7	MiR-0.7	MiL-0.7	MiD-0.7	MiC-0.7	MiM-0.7	MiF-0.7	MiN-0.7	MiG-0.7
	0.8	MiS-0.8	MiR-0.8	MiL-0.8	MiD-0.8	MiC-0.8	MiM-0.8	MiF-0.8	MiN-0.8	MiG-0.8
	1.0	MiS-1.0	MiR-1.0	MiL-1.0	MiD-1.0	MiC-1.0	MiM-1.0	MiF-1.0	MiN-1.0	MiG-1.0
	1.2	MiS-1.2	MiR-1.2	MiL-1.2	MiD-1.2	MiC-1.2	MiM-1.2	MiF-1.2	MiN-1.2	MiG-1.2

Alle Abmessungen sind auch in HSS-Co lieferbar / All dimensions are also available in Hi-Cobalt

MiG 25 x 10 x 15/11	0.4	MiGS-0.4	MiGR-0.4	MiGL-0.4	MiGD-0.4	MiGC-0.4	MiGM-0.4	MiGF-0.4	MiGN-0.4	MiGG-0.4
	0.5	MiGS-0.5	MiGR-0.5	MiGL-0.5	MiGD-0.5	MiGC-0.5	MiGM-0.5	MiGF-0.5	MiGN-0.5	MiGG-0.5
	0.6	MiGS-0.6	MiGR-0.6	MiGL-0.6	MiGD-0.6	MiGC-0.6	MiGM-0.6	MiGF-0.6	MiGN-0.6	MiGG-0.6
	0.7	MiGS-0.7	MiGR-0.7	MiGL-0.7	MiGD-0.7	MiGC-0.7	MiGM-0.7	MiGF-0.7	MiGN-0.7	MiGG-0.7
	0.8	MiGS-0.8	MiGR-0.8	MiGL-0.8	MiGD-0.8	MiGC-0.8	MiGM-0.8	MiGF-0.8	MiGN-0.8	MiGG-0.8
	1.0	MiGS-1.0	MiGR-1.0	MiGL-1.0	MiGD-1.0	MiGC-1.0	MiGM-1.0	MiGF-1.0	MiGN-1.0	MiGG-1.0
	1.2	MiGS-1.2	MiGR-1.2	MiGL-1.2	MiGD-1.2	MiGC-1.2	MiGM-1.2	MiGF-1.2	MiGN-1.2	MiGG-1.2
	1.5	MiGS-1.5	MiGR-1.5	MiGL-1.5	MiGD-1.5	MiGC-1.5	MiGM-1.5	MiGF-1.5	MiGN-1.5	MiGG-1.5
	1.6	MiGS-1.6	MiGR-1.6	MiGL-1.6	MiGD-1.6	MiGC-1.6	MiGM-1.6	MiGF-1.6	MiGN-1.6	MiGG-1.6
	1.8	MiGS-1.8	MiGR-1.8	MiGL-1.8	MiGD-1.8	MiGC-1.8	MiGM-1.8	MiGF-1.8	MiGN-1.8	MiGG-1.8
	2.0	MiGS-2.0	MiGR-2.0	MiGL-2.0	MiGD-2.0	MiGC-2.0	MiGM-2.0	MiGF-2.0	MiGN-2.0	MiGG-2.0

Alle Abmessungen sind auch in HSS-Co lieferbar / All dimensions are also available in Hi-Cobalt





Konvexe Rändelräder für den axialen Einsatz

Convex knurling wheels for axial feeding



Konvex geformte und geläppte Rändelräder maximieren die Standzeit, garantieren einen hochwertigen Rändel und eignen sich besonders zum axialen Verfahren.

Convex shaped knurling wheels with ultra smooth polished tooth profile are the best in precision finishes and tool life when axial feeding.

Rändelrad knurling wheel Type in mm	Teilung Pitch in mm	Bestell-Nr. Order-No. AA 	Bestell-Nr. Order-No. BR 30° 	Bestell-Nr. Order-No. BL 30° 	Bestell-Nr. Order-No. BR 45° 	Bestell-Nr. Order-No. BL 45° 
MRV 20 x 6 x 6	0.4	MRSV-0.4	MRRV-0.4	MRLV-0.4	MRDV-0.4	MRCV-0.4
	0.5	MRSV-0.5	MRRV-0.5	MRLV-0.5	MRDV-0.5	MRCV-0.5
	0.6	MRSV-0.6	MRRV-0.6	MRLV-0.6	MRDV-0.6	MRCV-0.6
	0.7	MRSV-0.7	-	-	MRDV-0.7	MRCV-0.7
	0.8	MRSV-0.8	MRRV-0.8	MRLV-0.8	MRDV-0.8	MRCV-0.8
	1.0	MRSV-1.0	MRRV-1.0	MRLV-1.0	MRDV-1.0	MRCV-1.0
	1.2	MRSV-1.2	MRRV-1.2	MRLV-1.2	MRDV-1.2	MRCV-1.2
	1.5	MRSV-1.5	MRRV-1.5	MRLV-1.5	MRDV-1.5	MRCV-1.5
	1.6	MRSV-1.6	MRRV-1.6	MRLV-1.6	MRDV-1.6	MRCV-1.6
2.0	MRSV-2.0	MRRV-2.0	MRLV-2.0	MRDV-2.0	MRCV-2.0	

Ausschließlich in HSS-Co nitriert mit geläpftem Zahnprofil lieferbar / Only available in Hi-Cobalt with extended wear surface treatment

Auch in Zollabmessungen lieferbar / Also available in inch dimensions

	konventionelle Form conventional shape	konventionelle Form mit Fase conventional form with chamfers	konvexe Formgebung convex shape
Vorteil Advantage		<p>höhere Standzeit Verminderung von Aufbauschneiden</p> <p><i>longer tool life reduction of a built up edge</i></p>	<p>sauber ausgeprägter Rändel hohe Standzeit Schonung von Halter und Spindel</p> <p><i>smooth precision finish long tool life low forces on holder and spindle bearings</i></p>
Nachteil Disadvantage	<p>bildet oft Aufbauschneiden auf Halter und Spindellagerung wirken hohe Kräfte</p> <p><i>often forms a built up edge high forces on holder and spindle bearings</i></p>	<p>Reduzierung der Krafteinwirkung auf Halter und Spindellagerung</p> <p><i>lower forces on holder and spindle bearing</i></p>	

The cut knurling process

Beim spanabhebenden Rändelfräsen wird unter Vorschub Material abgetragen. Die Belastungen auf





Werkstück und Maschine sind im Vergleich zum Rändelformen geringer, wodurch sich das Verfahren unter anderem auch eher zur Bearbeitung kleinerer Werkstückdurchmesser, dünnwandiger, weicher oder schwer verformbarer Materialien eignet. Hohe Präzision und Oberflächengüte zeichnen dieses Verfahren auch für die Herstellung von Sichträndeln aus. Im Gegensatz zum Rändelformen ist der Materialaufwurf gering, eine Oberflächenverdichtung findet jedoch kaum statt.





Das Ansetzen des Werkzeuges in der Werkstückmitte erfordert einen Einstich, Rändelungen zum Bund sind nicht möglich.

When cut knurling material is machined while feeding. In comparison with form knurling the stress to the bearings of the machine is much reduced. That's why this method is suited for small workpiece diameters, thin-walled, soft or poor deformable materials. High precision and surface quality distinguishes this method also for visible knurls. In contrast to form knurling there is almost no material displacement but also only a negligible surface compression. The beginning of a knurling in the middle of the workpiece requires a puncture. Knurling up to a shoulder is not possible.

Fräsrändelräder aus KHSS-E, mit geläpftem Zahnprofil

Cut knurling wheels made from 8 % Hi-Cobalt Steel with lapped tooth profile

Fräsrändelrad Cut knurling wheel Type in mm	Teilung Pitch in mm	Bestell-Nr. Order-No. AA 	Bestell-Nr. Order-No. BR 30° 	Bestell-Nr. Order-No. BL 30° 	Bestell-Nr. Order-No. BR 15° 	Bestell-Nr. Order-No. BL 15° 
CB 14,5 x 3 x 5	0.4	CBSX0.4	CBRX0.4	CBLX0.4	CBBX0.4	CBAX0.4
	0.5	CBSX0.5	CBRX0.5	CBLX0.5	CBBX0.5	CBAX0.5
	0.6	CBSX0.6	CBRX0.6	CBLX0.6	CBBX0.6	CBAX0.6
	0.7	CBSX0.7	CBRX0.7	CBLX0.7	-	-
	0.8	CBSX0.8	CBRX0.8	CBLX0.8	CBBX0.8	CBAX0.8
	0.9	CBSX0.9	-	-	-	-
	1.0	CBSX1.0	CBRX1.0	CBLX1.0	CBBX1.0	CBAX1.0
	1.2	CBSX1.2	CBRX1.2	CBLX1.2	CBBX1.2	CBAX1.2

Fräsrandelrad Cut knurling wheel Type in mm	Teilung Pitch in mm	Bestell-Nr. Order-No. AA 	Bestell-Nr. Order-No. BR 30° 	Bestell-Nr. Order-No. BL 30° 	Bestell-Nr. Order-No. BR 15° 	Bestell-Nr. Order-No. BL 15° 
CC 21,5 × 5 × 8	0.3	CCSX0.3	CCRX0.3	CCLX0.3	CCBX0.3	CCAX0.3
	0.4	CCSX0.4	CCRX0.4	CCLX0.4	CCBX0.4	CCAX0.4
	0.5	CCSX0.5	CCRX0.5	CCLX0.5	CCBX0.5	CCAX0.5
	0.6	CCSX0.6	CCRX0.6	CCLX0.6	CCBX0.6	CCAX0.6
	0.8	CCSX0.8	CCRX0.8	CCLX0.8	CCBX0.8	CCAX0.8
	1.0	CCSX1.0	CCRX1.0	CCLX1.0	CCBX1.0	CCAX1.0
	1.2	CCSX1.2	CCRX1.2	CCLX1.2	CCBX1.2	CCAX1.2
	1.5	CCSX1.5	CCRX1.5	CCLX1.5	CCBX1.5	CCAX1.5
	1.6	CCSX1.6	CCRX1.6	CCLX1.6	-	-
	2.0	CCSX2.0	CCRX2.0	CCLX2.0	CCBX2.0	CCAX2.0
	3.0	CCSX3.0	-	-	CCBX3.0	CCAX3.0
CG 8,9 × 2,5 × 4	0.3	CGSX0.3	CGRX0.3	CGLX0.3	CGBX0.3	CGAX0.3
	0.4	CGSX0.4	CGRX0.4	CGLX0.4	CGBX0.4	CGAX0.4
	0.5	CGSX0.5	CGRX0.5	CGLX0.5	CGBX0.5	CGAX0.5
	0.6	CGSX0.6	CGRX0.6	CGLX0.6	CGBX0.6	CGAX0.6
	0.7	CGSX0.7	CGRX0.7	CGLX0.7	CGBX0.7	CGAX0.7
	0.8	CGSX0.8	CGRX0.8	CGLX0.8	CGBX0.8	CGAX0.8
	0.9	CGSX0.9	CGRX0.9	CGLX0.9	CGBX0.9	CGAX0.9
	1.0	CGSX1.0	CGRX1.0	CGLX1.0	CGBX1.0	CGAX1.0
	1.2	CGSX1.2	CGRX1.2	CGLX1.2	CGBX1.2	CGAX1.2
CP 15 × 4 × 8	0.4	CPSX0.4	CPRX0.4	CPLX0.4	-	-
	0.5	CPSX0.5	CPRX0.5	CPLX0.5	CPBX0.5	CPAX0.5
	0.6	CPSX0.6	CPRX0.6	CPLX0.6	-	-
	0.7	CPSX0.7	CPRX0.7	CPLX0.7	CPBX0.7	CPAX0.7
	0.8	CPSX0.8	CPRX0.8	CPLX0.8	-	-
	1.0	CPSX1.0	CPRX1.0	CPLX1.0	CPBX1.0	CPAX1.0
	1.2	CPSX1.2	CPRX1.2	CPLX1.2	CPBX1.2	CPAX1.2
	1.5	CPSX1.5	CPRX1.5	CPLX1.5	CPBX1.5	CPAX1.5
	1.6	CPSX1.6	-	-	-	-
	1.8	CPSX1.8	-	-	CPBX1.8	CPAX1.8
2.0	CPSX2.0	-	-	-	-	
CV 25 × 6 × 8	0.4	CVSX0.4	CVRX0.4	CVLX0.4	-	-
	0.5	CVSX0.5	CVRX0.5	CVLX0.5	CVBX0.5	CVAX0.5
	0.6	CVSX0.6	CVRX0.6	CVLX0.6	-	-
	0.7	CVSX0.7	CVRX0.7	CVLX0.7	CVBX0.7	CVAX0.7
	0.8	CVSX0.8	CVRX0.8	CVLX0.8	CVBX0.8	CVAX0.8
	1.0	CVSX1.0	CVRX1.0	CVLX1.0	CVBX1.0	CVAX1.0
	1.2	CVSX1.2	CVRX1.2	CVLX1.2	CVBX1.2	CVAX1.2
	1.5	CVSX1.5	CVRX1.5	CVLX1.5	CVBX1.5	CVAX1.5
	1.6	CVSX1.6	CVRX1.6	CVLX1.6	-	-
	1.8	CVSX1.8	-	-	-	-
	2.0	CVSX2.0	CVRX2.0	CVLX2.0	CVBX2.0	CVAX2.0
	3.0	CVSX3.0	-	-	-	-

Rändelhalter „Standard“

Knurl holder “Standard”

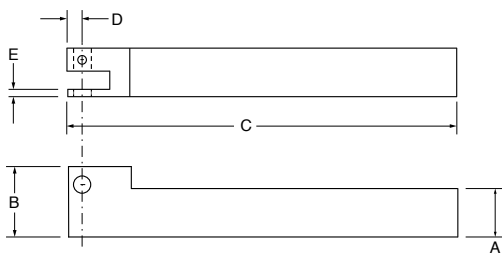

Der Halter

Klassischer und bewährter Halter zum Rändelformen.

The holder

Classic and approved form knurling holder

Anwendung

Zum Rändelformen im Einstech- und Axialverfahren.

To apply for

Form knurling tool for axial bump knurling and axial feeding

Mögliche Profile

Possible profiles



Einstich / radial feed

AA, BR 30°, BL 30°, BR 45°, BL 45°, GE 30°, GV 30°, GE 45°, GV 45°

Axial / axial feed

AA, BR 30°, BL 30°, BR 45°, BL 45°

Maschinentypen

Konventionelle, automatische und CNC-Drehmaschinen sowie Mehrspindlern und Langdrehautomaten

Machine types

Swiss type, multi-spindle, conventional, sliding-head and CNC lathes.

Bestell-Nr. Order-No. rechts / right	Bestell-Nr. Order-No. links / left	Rändelrad knurling wheel Type	Ersatzachsen spare pin	Halter Abmessungen (mm) / Holder dimensions (mm)				
				A	B	C	D	E
RABHM12R	RABHM12L	MM / MN	RACM412	12	18	90	4,0	2,5
RABHN16R	-	MM / MN	RACM412	16	22	100	4,8	2,5
RABHQ16R	-	MQ	RACM416	16	21,5	100	4,8	3,0
RABHR16R	RABHR16L	MR / MRV	RACM616	16	25,4	105	4,8	3,0
RABHR25R	-	MR / MRV	RACM625	25	32	127	4,8	3,0
RABHS20R	RABHS20L	MS / MW	RACM620	20	26,7	105	4,8	3,0
RABHW25R	-	MS / MW	RACM625	25	32	127	4,8	3,0
RABHU25R	-	MU	RACM625	25	32	127	4,8	3,0

Rändelhalter „RGE“

Knurl holder “RGE”

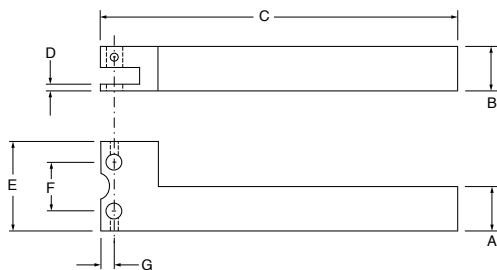

Der Halter Bewährter Halter zum Rändel-
formen.

The holder *Approved form knurling holder*

Anwendung Zum Formen von Kreuzrändel im
Einstech- und Axialverfahren.

To apply for *Form knurling tool for axial bump
knurling and axial feeding to
produce a diamond knurl*

Mögliche Profile
Possible profiles

AA	BR 30°	BL 30°	BR 45°	BL 45°
GE30°M	GV30°F	GE45°M	GV45°F	

Einstich / radial feed AA, BR 30°, BL 30°, BR 45°, BL 45°,
GE 30°, GV 30°, GE 45°, GV 45°

Axial / axial feed AA, BR 30°, BL 30°, BR 45°, BL 45°

Maschinentypen Konventionelle, automatische und
CNC-Drehmaschinen sowie Mehr-
spindlern und Langdrehautomaten

Machine types *Swiss type, multi-spindle, conven-
tional, sliding-head and CNC lathes.*

Bestell-Nr. Order-No.	Rändelrad knurling wheel Type	Ersatzachsen spare pin	Halter Abmessungen (mm) / Holder dimensions (mm)						
			A	B	C	D	E	F	G
RA2EP08	EP / EPV	RAC083	12,7	12,7	101,6	1,9	28,6	13,77	3,96
RA2EP10	EP / EPV	RAC083	15,87	12,7	101,6	1,9	28,6	13,77	3,96

Hinweis: Bestückt mit unseren konvexen MRV-Rändelrädern, erhält man besonders hochwertige Rändel

Note: In combination with our convex shaped MRV-Knurls you get a very smooth preci

Rändelhalter „Modular“

Knurl holder “Modular”



Der Halter

Der modulare Halter ermöglicht das Rändelformen mit einem oder zwei Rändelrädern. Die flexible Arretierung der Köpfe ermöglicht beim Einsatz von zwei Rändelrädern eine Zentrierung am Werkstück. Alle Köpfe und Schäfte sind untereinander kompatibel und austauschbar.

The holder

Modular design allows using this holder for single or two die operation. In two die operation a small adjustment allows the head to center itself upon setup. All heads and shanks are interchangeable.

Anwendung

Zum Rändelformen im Einstech- und Axialverfahren.

To apply for

Form knurling holder for axial and radial feeding.

Mögliche Profile

Possible profiles



Einstich / radial feed AA, BR 30°, BL 30°, BR 45°, BL 45°, GE 30°, GV 30°, GE 45°, GV 45°

Axial / axial feed AA, BR 30°, BL 30°, BR 45°, BL 45°

Maschinentypen

Konventionelle, automatische und CNC-Drehmaschinen sowie Mehrspindlern.

Machine types

Swiss type, multi-spindle, conventional and CNC lathes.

„Modular“ Komponenten “Modular” components

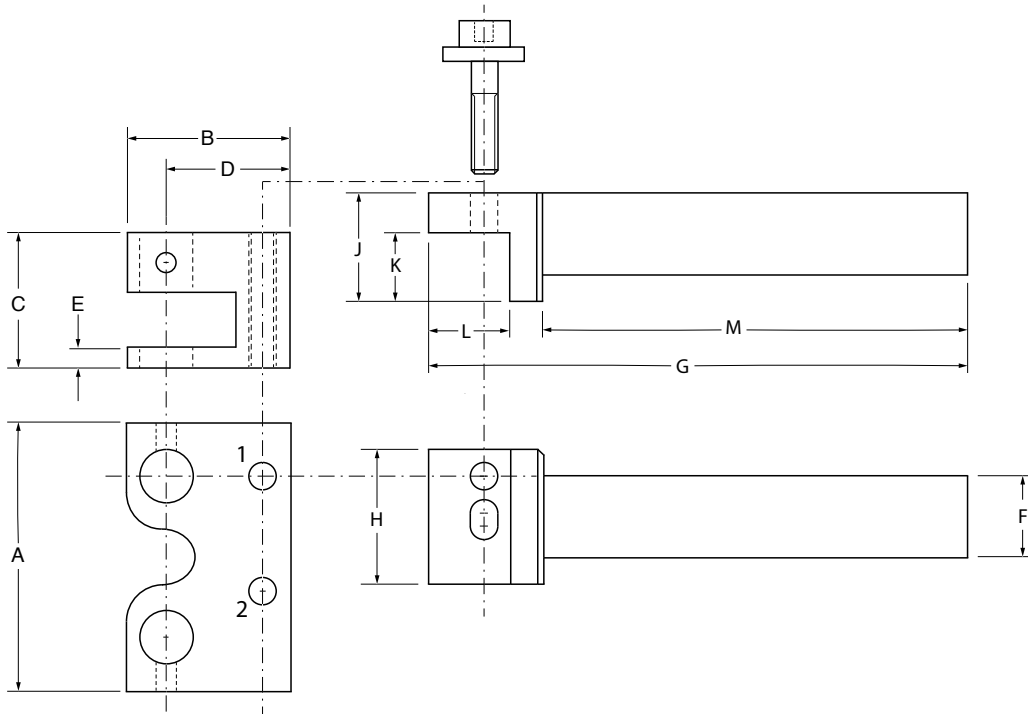

Modular-Köpfe / Modular heads							
Bestell-Nr. Order-No. Halter / holder	Rändelrad knurling wheel Type	Ersatzachsen spare pin	Kopf Abmessungen (mm) / Head dimensions (mm)				
			A	B	C	D	E
RA2BHMN	MN	RACM419	38,1	31,8	19,1	26,7	3,2
RA2BHMQ	MQ	RACM419	38,1	31,8	19,1	26,7	3,2
RA2BHMR	MR / MRV	RACM619	38,1	31,8	19,1	25,4	3,2
RA2BHMS	MS	RACM619	38,1	31,8	19,1	25,4	4,8
RA2BHMLM	ML	RAUTSP	41,3	31,8	15,9	24,2	-

Hinweis: Bestückt mit unseren konvexen MRV-Rändelrädern, erhält man besonders hochwertige Rändel.

Note: In combination with our convex shaped MRV-Knurls you get a very smooth precision finish.

Modular-Schäfte / Modular shafts							
Bestell-Nr. Order-No. Halter / holder	Schaft Abmessungen (mm) / Shaft dimensions (mm)						
	F	G	H	J	K	L	M
RASHM12	12	114	25,4	25,4	15,9	19,1	84
RASHM16	16	114	25,4	25,4	15,9	19,1	87
RASHM20	20	114	25,4	25,4	15,9	19,1	87
RASHM25	25	127	31,8	31,8	19,1	19,1	100

Rändelhalter „Selbstzentrierend RGE“

Knurl holder “Self Centering RGE”

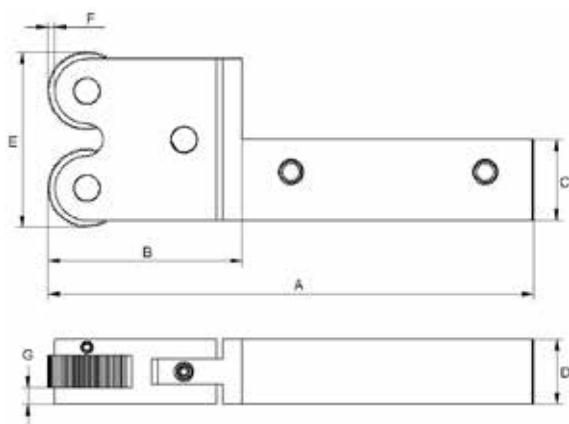

Der Halter

Robuster Halter zum rechts- und linksseitigen Rändelformen auf rechts- und linksdrehenden Maschinen. Die bewegliche Aufhängung des Kopfes zentriert die Rändelräder am Werkstück von selbst.

The holder

Heavy duty holder for right- and left-handed form knurling on right- and left-turning machines. Self centering design.

Anwendung

Zum Formen von Kreuzrändel im Einstech- und Axialverfahren.

To apply for

Form knurling tool preferred for axial and radial feed “Diamond” knurling.

Mögliche Profile Possible profiles



Einstich / radial feed AA, BR 30°, BL 30°, BR 45°, BL 45°, GE 30°, GV 30°, GE 45°, GV 45°

Axial / axial feed AA, BR 30°, BL 30°, BR 45°, BL 45°

Maschinentypen

Konventionellen, Automatischen, Langspindel-, Mehrspindel- und CNC-Drehmaschinen.

Machine types

Swiss type, multi-spindle, conventional, sliding-head and CNC lathes.

Bestell-Nr. Order-No. Halter / holder	Rändelrad knurling wheel Type	Ersatzachsen spare pin	Halter Abmessungen (mm) / Holder dimensions (mm)						
			A	B	C	D	E	F	G
RiM9100410	MM	RiEM9 12,4 HM	107	27	10	10	21	2	2
RiM9150416	MN	RiEM9 16,4 HM	130,5	40,5	16	16	32	1,5	3
RiM9150616	MQ	RiEM9 16,4 HM	130,5	40,5	16	16	32	1,5	3
RiM5200820	MR*/MRV*, MS	RiEM4/M5 20.06 HM	139,5	49	20	20	42	2,5	5
RiM5200825	MR*/MRV*, MS	RiEM4/M5 20.06 HM	139,5	49	25	20	42	2,5	5

* Mit zusätzlichen Unterlegscheiben / with additional washers

Hinweis: Bestückt mit unseren konvexen MRV-Rändelrädern, erhält man besonders hochwertige Rändel.

Note: In combination with our convex shaped MRV-Knurls you get a very smooth precision finish.

Rändelhalter „Bund-Standard“

Knurl holder “Shoulder-Standard”

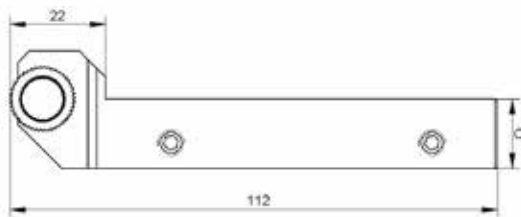

Der Halter Bewährter Halter, für bündige rechts- und linksseitige Anwendungen.

The holder Approved holder for left- and right-hand up to a shoulder use.

Anwendung Zum bündigen Rändelformen im Einstech- und Axialverfahren.

To apply for Form knurling tool for axial and radial feeding up to a shoulder.

Mögliche Profile
Possible profiles

AA	BR 30°	BL 30°	BR 45°	BL 45°
GE30°M	GV30°F	GE45°M	GV45°F	

Einstich / radial feed AA, BR 30°, BL 30°, BR 45°, BL 45°, GE 30°, GV 30°, GE 45°, GV 45°

Axial / axial feed AA, BR 30°, BL 30°, BR 45°, BL 45°

Maschinentypen Konventionellen, Automatischen, Langspindel-, Mehrspindel- und CNC-Drehmaschinen.

Machine types Swiss type, multi-spindle, conventional, sliding-head and CNC lathes.

Bestell-Nr. Order-No. Halter / holder	rechts- oder linksseitig RH or LH	Rändelrad knurling wheel Type	Ersatzachsen spare pin	Abmessungen Schaft shaft dimensions		Werkstück workpiece Ø in mm
				C (mm)	D	
RiM20150612R	rechts / right	Mi	RIEAM20/M21	12	16	3 – 100
RiM20150612L	links / left					
RiM20150616R	rechts / right			16		
RiM20150616L	links / left					

Rändelhalter „Bund-RGE“

Knurl holder “Shoulder-RGE”

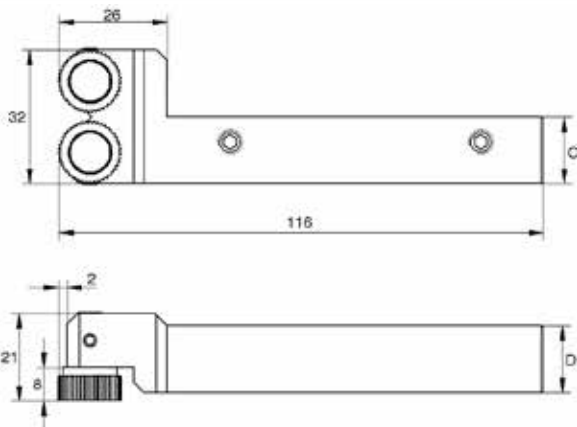

Der Halter

Bewährter Halter mit zwei Rändelrädern, zum bündigen rechts- oder linksseitigen Rändelformen.

The holder

Approved holder with two wheels for left- and right-hand up to a shoulder use.

Anwendung

Zum bündigen Rändelformen im Einstech- und Axialverfahren.

To apply for

Form knurling tool for axial and radial feeding up to a shoulder.

Mögliche Profile Possible profiles



Einstich / radial feed AA, BR 30°, BL 30°, BR 45°, BL 45°, GE 30°, GV 30°, GE 45°, GV 45°

Axial / axial feed AA, BR 30°, BL 30°, BR 45°, BL 45°

Maschinentypen

Konventionellen, Automatischen, Langspindel-, Mehrspindel- und CNC-Drehmaschinen.

Machine types

Swiss type, multi-spindle, conventional, sliding-head and CNC lathes.

Bestell-Nr. Order-No. Halter / holder	rechts- oder linksseitig RH or LH	Rändelrad knurling wheel Type	Ersatzachsen spare pin	Abmessungen Schaft shaft dimensions		Werkstück workpiece Ø in mm
				C	D (mm)	
RiM21150610R	rechts / right	Mi	RiEAM20/M21	12	16	3 – 100
RiM21150610L	links / left			12		
RiM21150616R	rechts / right			16		
RiM21150616L	links / left			16		

Rändelhalter „Bund-Schwer-Standard“ Knurl holder “Shoulder-Heavy-Standard”

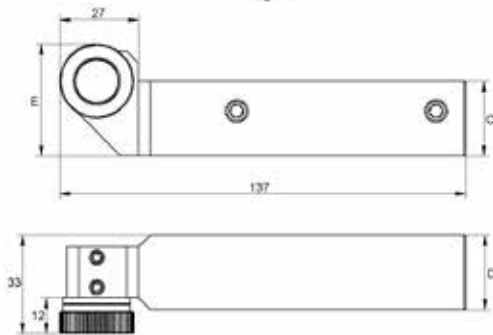

Der Halter

Bewährte und schwere Ausführung, für bündige rechts- und linksseitige Anwendungen.

The holder

Approved heavy-duty holder for left- and right-hand up to a shoulder use.

Anwendung

Zum bündigen Rändelformen im Einstech- und Axialverfahren.

To apply for

Form knurling tool for axial and radial feeding up to a shoulder.

Mögliche Profile Possible profiles

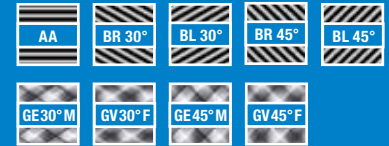

Einstich / radial feed AA, BR 30°, BL 30°, BR 45°, BL 45°, GE 30°, GV 30°, GE 45°, GV 45°

Axial / axial feed AA, BR 30°, BL 30°, BR 45°, BL 45°

Maschinentypen

Konventionellen, Automatischen, Langspindel-, Mehrspindel- und CNC-Drehmaschinen.

Machine types

Swiss type, multi-spindle, conventional, sliding-head and CNC lathes.

Bestell-Nr. Order-No. Halter / holder	rechts- oder linksseitig RH or LH	Rändelrad knurling wheel Type	Ersatzachsen spare pin	Abmessungen Schaft (mm) shaft dimensions (mm)			Werkstück workpiece Ø in mm
				C	D	E	
RiM10251020	beides / both	MiG	RiEAM10	20	25	30	8 – 200
RiM10251025	beides / both			25	25	35	

Rändelhalter „Bund-Schwer-RGE“ Knurl holder “Shoulder-Heavy-RGE”

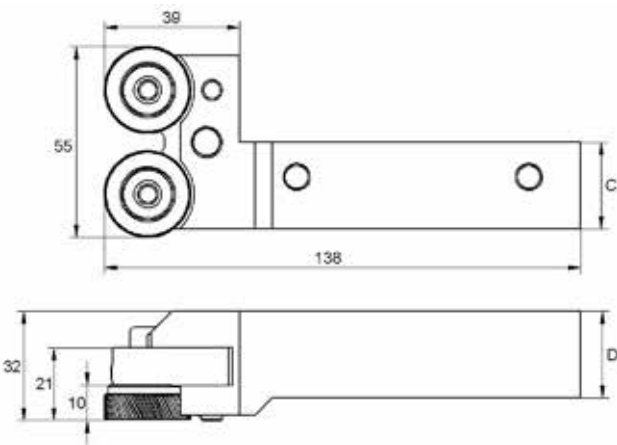

Der Halter

Schwere Ausführung des bewährten Halters mit zwei Rändelrädern, zum bündigen rechts- oder linksseitigen Rändelformen. Die bewegliche Aufhängung des Kopfes zentriert die Rändelräder am Werkstück von selbst.

The holder

Approved heavy-duty holder with two wheels for left- and right-hand up to a shoulder use with tilting head for self centering knurls on the workpiece.

Anwendung

Zum bündigen Rändelformen im Einstech- und Axialverfahren.

To apply for

Form knurling tool for axial and radial feeding up to a shoulder.

Mögliche Profile Possible profiles



Einstich / radial feed AA, BR 30°, BL 30°, BR 45°, BL 45°, GE 30°, GV 30°, GE 45°, GV 45°

Axial / axial feed AA, BR 30°, BL 30°, BR 45°, BL 45°

Maschinentypen

Konventionellen, Automatischen, Langspindel-, Mehrspindel- und CNC-Drehmaschinen.

Machine types

Swiss type, multi-spindle, conventional, sliding-head and CNC lathes.

Bestell-Nr. Order-No. Halter / holder	rechts- oder linksseitig RH or LH	Rändelrad knurling wheel Type	Ersatzachsen spare pin	Abmessungen Schaft shaft dimensions in mm		Werkstück workpiece Ø in mm
				C	D	
RiM11251020R	rechts / right	MiG	RiEAM10	20	25	8 – 200
RiM11251020L	links / left			20		
RiM11251025R	rechts / right			25		
RiM11251025L	links / left			25		

Rändelhalter „Schwenkbar“

Knurl holder “Swiveling”

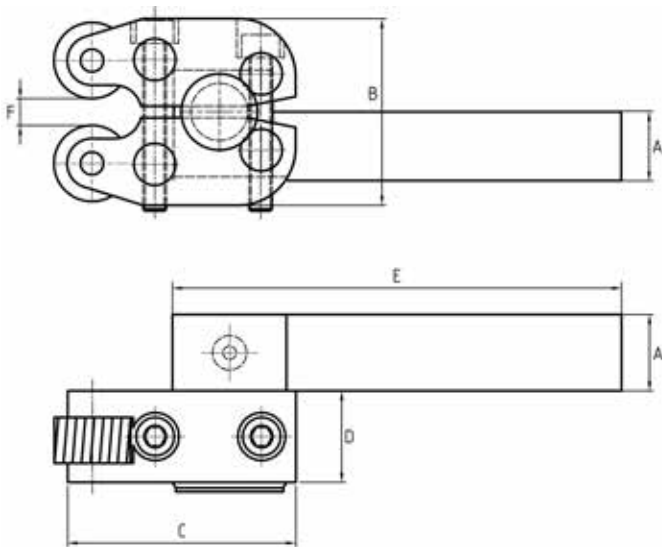

Der Halter

Halter zum selbstzentrierenden Rändelformen an kleineren und mittleren Drehmaschinen. Konstruktionsbedingt nimmt der Halter die Reaktionskräfte auf, die bei konventionellen Haltern auf die Lagerung der Maschinenspindel wirken. Durch die gegenüberliegende Anordnung der Rändelräder, wird die Verdrängung des Werkstückes auf ein Minimum reduziert.

The holder

Approved self centering form knurling holder with two wheels for small and medium sized lathes. Stress is absorbed by the tool and not transmitted to the bearings of the machine. It also eliminates bending risks on the workpiece as each knurl's pressure compensates one with each other.

Anwendung

Zum Rändelformen im Einstech- und Axialverfahren.

To apply for

Form knurling tool for axial and radial feeding.

Mögliche Profile Possible profiles



Einstich / radial feed AA, BR 30°, BL 30°, BR 45°, BL 45°, GE 30°, GV 30°, GE 45°, GV 45°

Axial / axial feed AA, BR 30°, BL 30°, BR 45°, BL 45°

Maschinentypen

Konventionellen, Automatischen, Langspindel-, Mehrspindel- und CNC-Drehmaschinen.

Machine types

Swiss type, multi-spindle, conventional, sliding-head and CNC lathes.

Bestell-Nr. Order-No. Halter / holder	Rändelrad knurling wheel Type	Ersatzachsen spare pin	Halter Abmessungen (mm) / holder dimensions (mm)					
			A	B	C	D	E	F (Ø)
RAMRCS12	MR / MRV	RACM619	12	65	60	19	100	0 – 22
RAMRCS16	MR / MRV	RACM619	16	65	60	19	100	0 – 22
RAMRCS20	MR / MRV	RACM619	20	65	60	19	100	0 – 22
RAMRCS25	MR / MRV	RACM619	25	65	60	19	100	0 – 22

Rändelhalter „Schwenkbar-Schwer“

Knurl holder “Swiveling-Heavy-Duty”

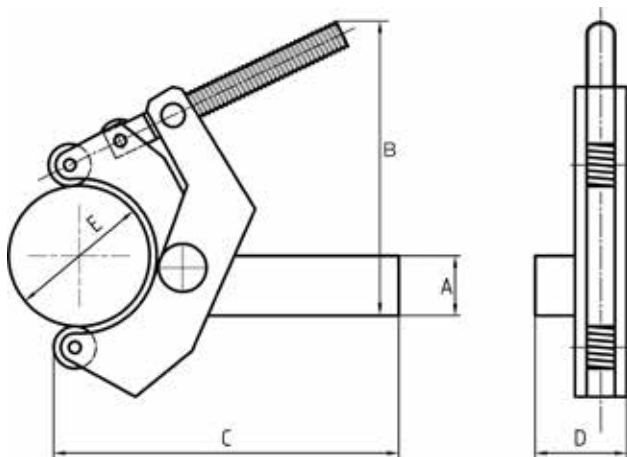

Der Halter

Schwere Ausführung zum selbstzentrierenden Rändelformen an mittleren und großen Drehmaschinen. Konstruktionsbedingt nimmt der Halter die Reaktionskräfte auf, die bei konventionellen Haltern auf die Lagerung der Maschinenspindel wirken. Durch die gegenüberliegende Anordnung der Rändelräder, wird die Verdrängung des Werkstückes auf ein Minimum reduziert.

The holder

Heavy duty self centering form knurling holder with two wheels for larger capacities on medium and large sized lathes. Stress is absorbed by the tool and not transmitted to the bearings of the machine. It also eliminates bending risks on the workpiece as each knurl's pressure compensates one with each other.

Anwendung

Zum Rändelformen im Einstech- und Axialverfahren.

To apply for

Form knurling tool for axial and radial feeding.

Mögliche Profile Possible profiles



Einstich / radial feed AA, BR 30°, BL 30°, BR 45°, BL 45°, GE 30°, GV 30°, GE 45°, GV 45°

Axial / axial feed AA, BR 30°, BL 30°, BR 45°, BL 45°

Maschinentypen

Konventionellen, Automatischen, Langspindel-, Mehrspindel- und CNC-Drehmaschinen.

Machine types

Swiss type, multi-spindle, conventional, sliding-head and CNC lathes.

Bestell-Nr. Order-No. Halter / holder	Rändelrad knurling wheel Type	Ersatzachsen spare pin	Abmessungen (mm) / holder dimensions (mm)				
			A	B	C	D	E (Ø in mm)
RASMW20	MS / MW / MR / MRV	RACM625	20	112	145	45	0 – 50
RASMW25	MS / MW / MR / MRV	RACM625	25	120	170	51	0 – 50

Fräsrändelhalter „RGE-VDI“ Cut-knurl holder “RGE-VDI”

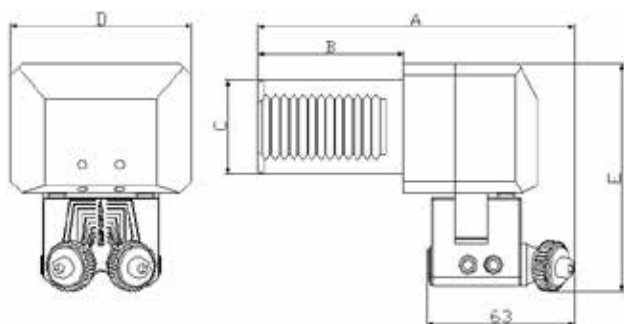

Der Halter

Halter mit selbstzentrierendem Schwenkkopf und skalierter Einstellmöglichkeit an den Werkstückdurchmesser. Einfaches Drehen des Kopfes ermöglicht Links- oder Rechtsrändelungen. Modulare Bauweise, der Schwenkkopf kann auf unterschiedlichen Schäften montiert werden.

The holder

Approved cut knurling holder with a tilting and scaled head for a better knurl alignment to the workpiece diameter and easy adjustment of the parallelity. Possibility to work on right- and left-handed lathes just turning over the head. The modular system allows the use of several different shanks.

Anwendung

Fräsrändelwerkzeug ausschließlich zum axialen Verfahren. Das Ansetzen des Werkzeuges in der Werkstückmitte erfordert einen Einstich, Rändelungen zum Bund sind nicht möglich.

To apply for

Cut knurling tool only for axial feeding. The beginning of a knurling in the middle of the workpiece requires a puncture. Knurlings up to a shoulder are not possible.

Mögliche Profile Possible profiles



Axial / axial feed

RGE 30°, RGE 45°, RGE 60°

Maschinentypen

CNC-Drehmaschinen mit Revolveraufnahme nach DIN 69880

Machine types

CNC lathes equipped with a DIN 69880 turret.

Bestell-Nr. Order-No. Halter / holder	rechts- oder linksseitig RH or LH	Fräsrändelrad Cut knurl Type	Ersatzachsen spare pin	in mm					
				A	B	C	D	E	Ø Bereich / range
RiVDI215530R	rechts / right	CC	RiEAT2155	126	55	30	68	95	5 – 250
RiVDI215530L	links / left			126	55	30	68	95	5 – 250
RiVDI215540R	rechts / right			136	63	40	78	98	5 – 250
RiVDI215540L	links / left			136	63	40	78	98	5 – 250

Fräsrändelhalter „RAA“ Cut-knurl holder “RAA”

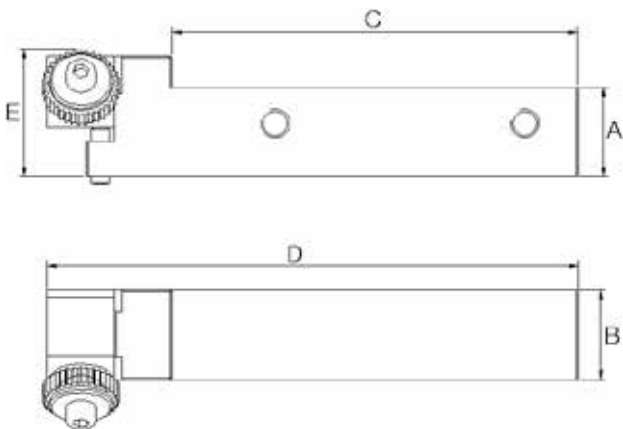

Der Halter

Robuster und bewährter Halter mit einfacher Einstellmöglichkeit der Parallelität und skaliertem Schwenkkopf zur Einstellung des Angriffswinkels. Links- und Rechtsrändel durch Drehung des Kopfes möglich. Durch den Modulaufbau kann der Schwenkkopf auf unterschiedlichen Haltern montiert werden.

The holder

Robust and approved cut knurling holder with easy adjustment of the parallelity and scaled head for the adjustment of the angle. Possibility to work on right- and left-handed lathes just turning over the head. The modular system allows the use of several different shanks.

Anwendung

Fräsrändelwerkzeug ausschließlich zum axialen Verfahren. Das Ansetzen des Werkzeuges in der Werkstückmitte erfordert einen Einstich, Rändelungen zum Bund sind nicht möglich.

To apply for

Cut knurling tool only for axial feeding. The beginning of a knurling in the middle of the workpiece requires a puncture. Knurlings up to a shoulder are not possible.

Mögliche Profile Possible profiles



Axial / axial feed

AA, BR 30°, BL 30°

Maschinentypen

Drehautomaten, konventionellen, CNC und Mehrspindeldrehmaschinen





Machine types

Multi-spindle, conventional, sliding-head and CNC lathes.

Bestell-Nr. Order-No. Halter / holder	rechts- oder linksseitig RH or LH	Fräsrändelrad Cut knurl Type	Ersatzachsen spare pin	in mm					
				A	B	C	D	E	Ø Bereich / range
RiMFS892508R	rechts / right	CG	RiES8925	8	8	90	110	16	1,5 – 12
RiMFS892508L	links / left			8	8	90	110	16	1,5 – 12
RiMFS892510R	rechts / right			10	10	90	110	16	1,5 – 12
RiMFS892510L	links / left			10	10	90	110	16	1,5 – 12
RiMFS892512R	rechts / right			12	12	90	110	16	1,5 – 12
RiMFS892512L	links / left			12	12	90	110	16	1,5 – 12
RiMFS145314	beides / both	CB	RiEAT1453	14	16	74	100	22	4 – 50
RiMFS145316	beides / both			16	16	74	100	22	4 – 50
RiMFS215520	beides / both	CC	RiEAT2155	20	25	114	150	32	5 – 250
RiMFS215525	beides / both			25	25	114	150	32	5 – 250

Hinweis: Welche Fräsrändelräder für welches Rändelprofil?

Note: Which cut knurling wheels for which profile?

Rändelprofil Knurl profile	Fräsrändelrad Cut knurl type	
AA 	BR 30°	rechtsdrehend right-handed
BR 30° 	AA	
AA 	BL 30°	linksdrehend left-handed
BL 30° 	AA	

Fräsrändelhalter „RGE“ Cut-knurl holder “RGE”

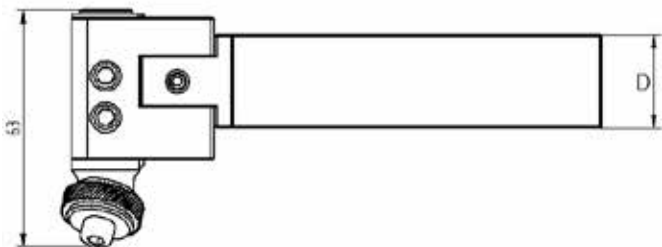
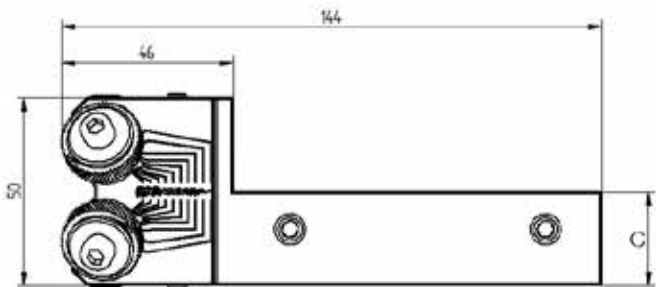

Der Halter

Bewährter Halter mit selbstzentrierendem Schwenkkopf, skalierter Einstellmöglichkeit an den Werkstückdurchmesser und einfacher Korrektur der Parallelität. Modulare Bauweise, der Schwenkkopf kann auf unterschiedlichen Schäften montiert werden. Abhängig vom verwendeten Schaft, kann der Halter auf links- oder rechtsdrehenden Maschinen eingesetzt werden.

The holder

Approved cut knurling holder with a tilting and scaled head for a better knurl alignment to the workpiece diameter and easy adjustment of the parallelity. Possibility to work on right and left-handed lathes just turning over the head. The modular system allows the use of several different shanks.

Anwendung

Fräsrändelwerkzeug ausschließlich zum axialen Verfahren. Das Ansetzen des Werkzeuges in der Werkstückmitte erfordert einen Einstich, Rändelungen zum Bund sind nicht möglich.

To apply for

Cut knurling tool only for axial feeding. The beginning of a knurling in the middle of the workpiece requires a puncture. Knurlings up to a shoulder are not possible.

Mögliche Profile

Possible profiles



Axial / axial feed

RGE 30°, RGE 45°, RGE 60°

Maschinentypen

Drehautomaten, konventionellen, CNC und Mehrspindeldrehmaschinen



Machine types

Multi-spindle, conventional, sliding-head and CNC lathes.

Bestell-Nr. Order-No. Halter / holder	rechts- oder linksseitig RH or LH	Fräsrändelrad Cut knurl Type	Ersatzachsen spare pin	in mm					
				A	B	C	D	E	Ø Bereich / range
RiMF892508R	rechts / right	CG	RiEAT8925	8	8	80	107	25	1,5 – 12
RiMF892508L	links / left			8	8	80	107	25	1,5 – 13
RiMF892510R	rechts / right			10	10	80	107	25	1,5 – 14
RiMF892510L	links / left			10	10	80	107	25	1,5 – 14
RiMF892512R	rechts / right			12	12	80	107	25	1,5 – 15
RiMF892512L	links / left			12	12	80	107	25	1,5 – 15
RiMF145314R	rechts / right	CB	RiEAT1453	14	16	78	120	44	5 – 50
RiMF145314L	links / left			14	16	78	120	44	5 – 50
RiMF145316R	rechts / right			16	16	78	120	44	5 – 51
RiMF145316L	links / left			16	16	78	120	44	5 – 51
RiMF215520	beides / both	CC	RiEAT2155	20	25	112	165	63	6 – 250
RiMF215525	beides / both			25	25	112	165	63	6 – 250

Hinweis: Welche Fräsrändelräder für welches Rändelprofil?

Note: Which cut knurling wheels for which profile?

Rändelprofil Knurl profile	Fräsrändelrad Cut knurl type
GE 30° 	AA + AA
GE 45° 	BL 15° + BR 15°
GE 60° 	BL 30° + BR 30°

Stirnrändelhalter „Starr“ und „Einstellbar“

Face-knurling holder “Fixed” and “Adjustable”

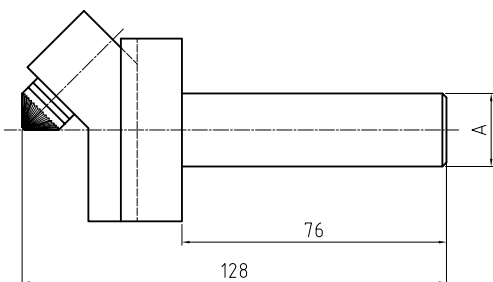
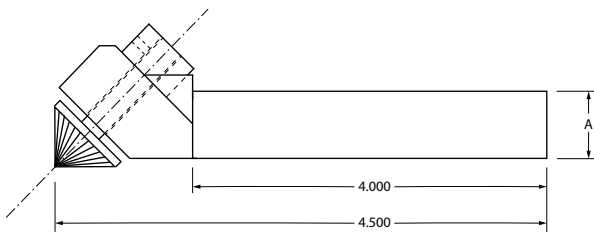

Der Halter

Sowohl der starre wie auch der einstellbare Stirnrändelhalter sind in einer einfachen und in einer schweren Ausführung lieferbar. Der einstellbare Halter entspricht im Aufbau dem des starren Halters, durch entsprechende Einstellung können jedoch Durchmesser bis 64 mm gerändelt werden. Bei Rändelungen größer 32 mm befindet sich die Werkzeugspitze nicht im Zentrum, bei relativ schmalen Rändelflächen, deren Teilungsdifferenz nicht größer 10 % ist, kann mit dieser Methode jedoch ein akzeptabler Rändel gefertigt werden.

The holder

The fixed and also the adjustable face-knurling holder are available in a standard or heavy duty version. The buildup of the fixed and the adjustable holder is the same, the adjustable holder allows to double the knurl up to a diameter of 64 mm. When knurling on these larger diameter the tip of the die is not on the center of the part, but if the knurl “band” on the part is narrow an acceptable impression can be made. In general if the rate of pitch change on the part is within 10 % of the rate of pitch change on the die a good straight knurl will be made.

Anwendung

Zum radialen Rändelformen an Stirnseiten.

To apply for

Face form knurling tool for radial feeding.

Mögliche Profile Possible profiles



Axial / axial feed

AA

Maschinentypen

Konventionellen, Mehrspindel- und CNC-Drehmaschinen.

Machine types

Conventional, multi-spindle and CNC lathes.

Metrische Halter „Starr“ / <i>Metric holder „Fixed“</i>			Metrische Halter Einstellbar / <i>Metric holder „Adjustable“</i>		
Bestell-Nr. Order-No. Standard	Bestell-Nr. Order-No. Verstärkt <i>heavy-duty</i>	A (mm)	Bestell-Nr. Order-No. Standard	Bestell-Nr. Order-No. Verstärkt <i>heavy-duty</i>	A (mm)
RAKTSM16	RAKTHM16	16	RAKT45M16	RAHD45M16	16
RAKTSM20	RAKTHM20	20	RAKT45M20	RAHD45M20	20
RAKTSM25	RAKTHM25	25	RAKT45M25	RAHD45M25	25

Stirnrändeleinsätze TIN-beschichtet *Face knurling dies with TIN coating*

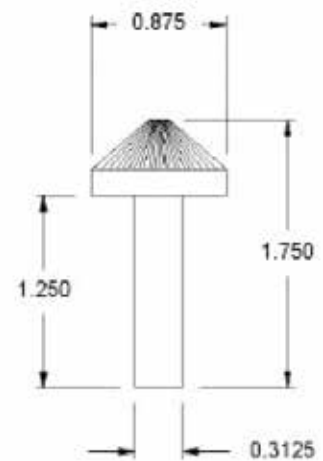
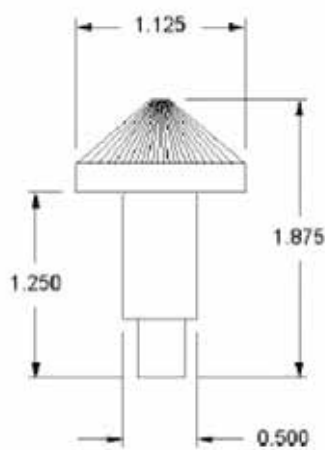

Teilung / <i>pitch</i>	Standart / <i>standard</i>			Verstärkte Ausführung / <i>heavy-duty</i>		
	Zähne / <i>teeth</i>	in HSS	in HSS-Co	Zähne / <i>teeth</i>	in HSS	in HSS-Co
fein / <i>fine</i>	72	KT F	KT XF	72	KT HDF	KT HDXF
mittelfein / <i>med-fine</i>	60	KT MF	KT XMF	60	KT HDMF	KT HDXMF
Mittel / <i>medium</i>	48	KT M	KT XM	48	KT HDM	KT HDXM
mittelgrob / <i>med-coarse</i>	36	KT MC	KT XMC	36	KT HDMC	KT HDXMC
grob / <i>coarse</i>	24	KT C	KT XC	24	KT HDC	KT HDXC

Ø Werkstück <i>workpiece</i>	Idealer Kontaktpunkt <i>Ideal die contact Point</i>	Fein / <i>fine</i> 72 Zähne / <i>teeth</i>	Mittelfein <i>med. fine</i> 60 Zähne / <i>teeth</i>	Mittel / <i>medium</i> 48 Zähne / <i>teeth</i>	Mittelgrob / <i>med-coarse</i> 36 Zähne / <i>teeth</i>	Grob / <i>coarse</i> 24 Zähne / <i>teeth</i>
.250	.177	130 TPI	108 TPI	87 TPI	65 TPI	43 TPI
.500	.353	65 TPI	54 TPI	43 TPI	32 TPI	22 TPI
.750	.530	43 TPI	36 TPI	29 TPI	22 TPI	14 TPI
1.000	.707	32 TPI	27 TPI	22 TPI	16 TPI	11 TPI
1.237	.875	26 TPI	22 TPI	17 TPI	13 TPI	9 TPI
1.591	1.125	20 TPI	17 TPI	14 TPI	10 TPI	7 TPI

Rändelhalter „Bohrung“

Internal holder “Bore”



Der Halter

Rändelhalter zur exzentrischen Anwendung für Rändelungen in Bohrungen. Der runde Schaft besitzt eine gefräste Fläche zur Vereinfachung des Werkzeugwechsels. Die maximale Tiefe ist abhängig von den Eigenschaften des zur rändelnden Materials.

The holder

Internal Holders are intended to be used boring bar style (off center). Each of them has flats on diameter of shank to allow mounting in tool post. Maximum depth that can be knurled will vary with toughness of material to be knurled.

Anwendung

Zum dezentralen Rändelformen in Bohrungen im Einstech- und Axialverfahren.

To apply for

Internal form knurling holder for boring bar style (off center) for axial and radial feeding.

Mögliche Profile Possible profiles

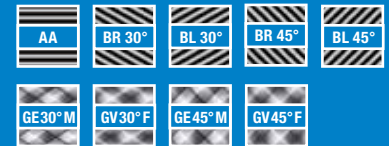

Einstich / radial feed AA, BR 30°, BL 30°, BR 45°, BL 45°, GE 30°, GV 30°, GE 45°, GV 45°

Axial / axial feed AA, BR 30°, BL 30°, BR 45°, BL 45°

Maschinentypen

Konventionelle, Lang-, Universal-, Mehrspindel-, CNC und Kurzdrehmaschinen, Dreh-/Fräszentren

Machine types

Manual, automatic, Swiss type, sliding-head, multi-spindle and CNC Lathes

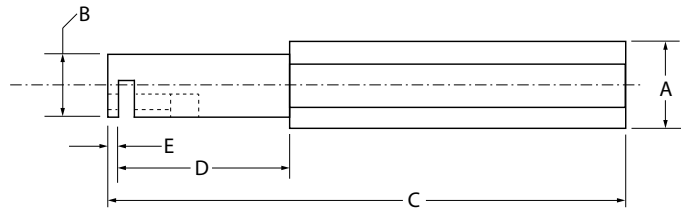

Bestell-Nr. Order-No. Halter / holder	Rändelrad knurling wheel Type	Ersatz- achsen spare pin	Halter Abmessungen (Zoll) / holder dimensions (inch)					min. Ø innen / bore mm / inch
			A	B	C	D	E	
RAIBP12C	BP	C 082	.750	.42	5.00	1.60	.10	13,7 / .54
RAIBP12CS	BP	C 082	.750	.42	5.00	0.65	.10	13,7 / .54
RAIEP16D	EP	C 113	1.00	.73	6.00	2.10	.10	20,3 / .80
RAIGK20E	GK	C 144	1.25	.98	7.00	3.10	.11	26,4 / 1.04
RAIKP20F	KP	C 144	1.25	1.23	8.00	4.10	.11	33 / 1.30

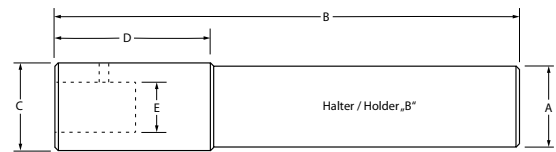
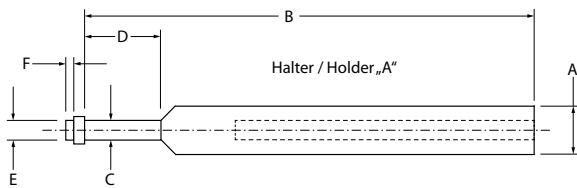

Bestell-Nr. Order-No.	Rändelrad knurling wheel Type	Ersatz- achsen spare pin	Halter Abmessungen (Zoll) / Holder dimensions (inch)						min. Ø innen / bore mm / inch
			A	B	C	D	E	F	
Halter „A“ / Holder „A“									
RAIBP08A	BP	RAINTPBP	.500	6.00	.290	1.00	.250	.078	9,4 / .370
RAIBP10B			.625	6.00	.290	1.00	.250	.078	9,4 / .370
RAIBP10BS			.625	6.00	.290	1.250	.250	.078	9,4 / .370
Halter „B“ / Holder „B“									
RAIML10	ML	RAUTSP	.625	6.00	.700	2.00	.470	0.00	24,1 / .950
RAIML12			.750	6.00	.700	2.00	.470	0.00	24,1 / .950
RAIML16			1.00	6.00	.700	2.00	.470	0.00	24,1 / .950

Auf Wunsch kann der Schaft auf metrische Abmessungen abgeändert werden.
If required the shafts can be machined in metric dimensions.

Rändelhalter „Konisch“

Knurl holder “Conical”

Der Halter

Dieser Halter ermöglicht konisches Rändelformen, speziell nach DIN 72783 auf rechts- und linksdrehenden Maschinen. Seine Modularbauweise ermöglicht den Einsatz auf unterschiedlichen Schäften sowie eine einfache Einstellung des Werkstückdurchmessers. Abweichungen von Revolver und Maschinenachse werden durch eine automatische Zentrierung ausgeglichen.

Konstruktionsbedingt nimmt der Halter die Reaktionskräfte auf, die bei konventionellen Haltern auf die Lagerung der Maschinenspindel wirken. Durch die gegenüberliegende Anordnung der Rändelräder, wird die Verdrängung des Werkstückes auf ein Minimum reduziert.

The holder

This form knurling holder enables conical knurlings on right- and left-handed lathes especially in DIN-72783. The modular system allows the use of several different shanks keeping the same components. A threaded spindle enables easy adjustment to the workpiece's diameter and an auto-centering system compensates a possible disalignment between the turret and the machine axis.

Mechanical stress is stood by the holder and not transmitted to the bearings of the machine. Even the bending risk in the workpiece is eliminated as each knurl's pressure compensates one with each other.



Anwendung

Zum Formen konischer Rändel im Axialverfahren.

To apply for

Form knurling tool for axial feeding.

Mögliche Profile Possible profiles

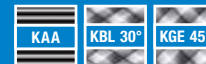

Axial / axial feed

KAA, KBL 30°, KGE 45°

Maschinentypen

Konventionellen, Automatischen, Langspindel-, Mehrspindel- und CNC-Drehmaschinen.

Machine types

Manual, automatic, Swiss type, multi-spindle and CNC Lathes

Bestell-Nr. Order No. Halter / holder	rechts- oder linksseitig	Rändelrad knurling wheel Type	Ersatzachsen spare pin	Ø Werkstück workpiece	Schaft shaft
Ri1210100	beides / both	konisch / conical	EM 16 HM	1 – 12	nach Kundenwunsch / as required

Rändelkopf

Knurling-head

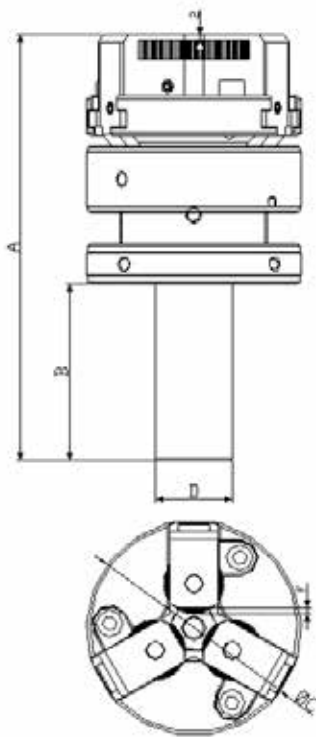

Der Halter

Rändelköpfe sind besonders zum Rändeln von kleinen Durchmessern geeignet. Die drei Rändelradaufnahmen werden über einen zentralen Stellring synchron justiert, was eine einfache Einstellung auf den Werkstückdurchmesser ermöglicht. Eine flexible Verbindung von Schaft und Kopf gleicht kleinere Zentrierungsfehler zwischen Werkzeug und Werkstück automatisch aus.

The holder

This three wheeled form knurling tool performs knurlings on small diameter workpieces. Three knurl jaws are moved by a synchronizing ring that allows an easy adjustment to the workpiece's diameter. The coupling between the shank and the head has an auto adjusting system to compensate differences between the turret and the chuck of the machine.

Anwendung

Stirnseitiges Rändelformen im Axialverfahren.

To apply for

Face-knurling for axial feeding

Mögliche Profile Possible profiles



Axial / axial feed

AA, GE 30°, GE 45°

Maschinentypen

Konventionelle und CNC-Drehmaschinen, Langdrehautomaten und Mehrspindler.

Machine types

Conventional, CNC, multi-spindle, sliding head and Swiss type lathes.

Bestell-Nr. Order-No. Halter / holder	Rändelrad knurling wheel Type	Ersatzachsen spare pin	Abmessungen / Dimensions (mm)					
			Bereich / range in mm		A	B	C	D in mm Schaft / Shank
			Ø in mm	Länge / length				
Ri01170100	MM	RiEM171004	2 – 6 6,1 – 10	endlos / endless 12	107	57,5	44	16
RiM17200643022	MR / MRV	RiEM172006	4 – 6 6,1 – 14 14,1 – 20 20,1 – 30	endlos / endless 60 20 10	139	57,5	70	20 oder nach Kundenwunsch / or as required

Vorschubgeschwindigkeiten beim Rändelumformverfahren

Feed and speed charts for form knurling

Werkstoff Material	Ø Werkstück Ø Workpiece (mm)	Ø Rändelrad Ø Knurling wheel (mm)	Vc (m/min)	Radialer Vorsch. Radial feed (mm / rev)	Axialer Vorschub bei Teilungen Axial feeding for pitches (mm / rev)			
					0,3 – 0,6	0,6 – 1,2	1,2 – 1,6	1,6 – 2,0
60 Kg Stahl Steel	< 10	10	25 – 55	0,04 – 0,08	0,2	0,12	0,08	0,06
	10 – 50	15			0,26	0,16	0,12	0,08
	50 – 100	20	0,3		0,18	0,15	0,1	
			0,3		0,18	0,15	0,1	
			0,4		0,26	0,16	0,12	
> 250	25	0,4	0,26	0,16	0,12			
90 Kg Stahl Steel	< 10	10	20 – 50	0,04 – 0,08	0,18	0,10	0,06	0,04
	10 – 50	15			0,24	0,14	0,10	0,06
	50 – 100	20	0,28		0,16	0,12	0,08	
			0,28		0,16	0,12	0,08	
	100 – 250	25	0,36		0,24	0,14	0,10	
Edelstahl Stainless Steel	> 250 < 10	10	20 – 40	0,04 – 0,08	0,36	0,24	0,14	0,10
	10 – 50	15			0,14	0,08	0,06	0,04
			0,20		0,12	0,10	0,06	
			0,25		0,15	0,12	0,08	
	50 – 100	20	0,25		0,15	0,12	0,08	
> 250	25	0,30	0,20	0,14	0,10			
Stahlguss Cast Steel	10	10	20 – 40	0,04 – 0,08	0,14	0,08	0,06	0,04
	10 – 50	15			0,20	0,12	0,10	0,06
			0,25		0,15	0,12	0,08	
	50 – 100	20	0,25		0,15	0,12	0,08	
	100 – 250	25	0,30		0,20	0,14	0,10	
> 250	0,30		0,20	0,14	0,10			
Aluminium Aluminium	< 10	10	25 – 60	0,04 – 0,08	0,12	0,08	0,05	0,04
	10 – 50	15			0,16	0,10	0,08	0,06
			0,20		0,15	0,10	0,06	
	50 – 100	20	0,20		0,15	0,10	0,06	
	100 – 250	25	0,26		0,18	0,12	0,08	
> 250	0,26		0,18	0,12	0,08			
Blech Sheet Metal	< 10	10	35 – 75	0,04 – 0,08	0,25	0,15	0,10	0,08
	10 – 50	15			0,30	0,20	0,15	0,10
			0,40		0,25	0,20	0,15	
	50 – 100	20	0,40		0,25	0,20	0,15	
	100 – 250	25	0,50		0,30	0,20	0,15	
> 250	0,50		0,30	0,20	0,15			
Bronze Bronze	< 10	10	25 – 55	0,04 – 0,08	0,20	0,12	0,08	0,06
	10 – 50	15			0,26	0,16	0,12	0,08
			0,30		0,18	0,15	0,10	
	50 – 100	20	0,30		0,18	0,15	0,10	
	100 – 250	25	0,40		0,26	0,16	0,12	
> 250	0,40		0,26	0,16	0,12			

Die Werte dieser Tabelle sind Richtgrößen und sollen lediglich zur Orientierung dienen. Durch variieren der Werte können maschinenspezifisch bessere Resultate erreicht werden. Beim Rändelformen entsteht ein Werkstoffaufwurf, der eine Vergrößerung des Werkstückdurchmessers zur Folge hat. Abhängig von Werkstoff und Teilung des Rändels, erhöht sich der Werkstückdurchmesser zwischen 40 und 60 % der Werkzeuggesteuerung.

The values above are published merely as a guide. Optimal results can be achieved after try-out process on site. Form knurling is a cold-forming process, whereby the diameter of the workpiece increases. Depending on material and pitch of the knurl the diameter of the workpiece increases between 40 and 60 % of the pitch.

Schnitt- und Vorschubgeschwindigkeiten beim Rändelfräsen

Feed and speed charts for cut knurling

Werkstoff Material	Ø Werkstück Ø Workpiece (mm)	Ø Rändelrad Ø Knurling wheel (mm)	Vc (m/min)	Radialer Vorsch. Radial feed (mm / rev)	Axialer Vorschub bei Teilung Axial feeding for pitches (mm / rev)			
					0,3 – 0,6	0,6 – 1,2	1,2 – 1,6	1,6 – 2,0
60 Kg Stahl Steel	< 12	8,9	35	0,04 – 0,08	0,14	0,09	0,06	0,05
			45		0,15	0,10	0,08	0,06
	12 – 50	14,5	40		0,20	0,13	0,10	0,07
			60		0,22	0,15	0,12	0,08
	50 – 100	21,5	55		0,25	0,18	0,12	0,08
	100 – 250		50		0,30	0,20	0,13	0,09
> 250	42	95	0,32	0,21	0,14	0,1		
90 Kg Stahl Steel	< 12	8,9	25	0,04 – 0,10	0,12	0,07	0,05	0,05
			35		0,13	0,08	0,07	0,05
	12 – 50	14,5	30		0,18	0,11	0,08	0,05
			45		0,20	0,13	0,1	0,06
	50 – 100	21,5	40		0,23	0,16	0,10	0,06
	100 – 250		35		0,28	0,18	0,12	0,07
> 250	42	60	0,30	0,20	0,12	0,08		
Edelstahl Stainless Steel	< 12	8,9	22	0,04 – 0,10	0,12	0,08	0,05	0,04
			30		0,13	0,09	0,07	0,05
	12 – 50	14,5	28		0,17	0,11	0,09	0,06
			35		0,19	0,13	0,10	0,07
	50 – 100	21,5	32		0,21	0,15	0,10	0,07
	100 – 250		30		0,26	0,17	0,11	0,08
> 250	42	50	0,27	0,18	0,12	0,09		
Stahlguss Cast Steel	< 12	8,9	22	0,04 – 0,10	0,12	0,08	0,05	0,04
			30		0,13	0,09	0,07	0,05
	12 – 50	14,5	28		0,17	0,11	0,09	0,06
			35		0,19	0,13	0,10	0,07
	50 – 100	21,5	32		0,21	0,15	0,10	0,07
	100 – 250		30		0,26	0,17	0,11	0,08
> 250	42	50	0,27	0,18	0,12	0,09		
Aluminium Aluminium	< 12	8,9	70	0,04 – 0,10	0,18	0,11	0,08	0,06
			80		0,20	0,13	0,10	0,07
	12 – 50	14,5	70		0,25	0,16	0,13	0,09
			110		0,27	0,18	0,14	0,09
	50 – 100	21,5	100		0,31	0,23	0,15	0,10
	100 – 250		95		0,38	0,25	0,16	0,11
> 250	42	150	0,40	0,26	0,18	0,13		
Blech Sheet Metal	< 12	8,9	60	0,04 – 0,10	0,15	0,09	0,06	0,05
			70		0,17	0,10	0,07	0,06
	12 – 50	14,5	60		0,21	0,14	0,11	0,07
			100		0,22	0,16	0,12	0,07
	50 – 100	21,5	90		0,26	0,19	0,13	0,08
	100 – 250		85		0,32	0,21	0,14	0,09
> 250	42	140	0,34	0,22	0,15	0,11		
Bronze Bronze	< 12	8,9	35	0,04 – 0,10	0,13	0,07	0,05	0,05
			45		0,15	0,08	0,06	0,05
	12 – 50	14,5	40		0,19	0,12	0,10	0,06
			60		0,20	0,14	0,10	0,06
	50 – 100	21,5	55		0,24	0,17	0,11	0,07
	100 – 250		50		0,30	0,20	0,12	0,08
> 250	42	95	0,32	0,20	0,13	0,10		

Die Werte dieser Tabelle sind Richtgrößen und sollen lediglich zur Orientierung dienen. Durch variieren der Werte können maschinenspezifisch bessere Resultate erreicht werden. / The values above are published merely as a guide. Optimal results can be achieved after try-out process on site.



ROLLWALZTECHNIK Abele + Hötlich GmbH
Jahnstraße 33–35, D-78234 Engen
Telefon: +49-(0) 77 33-94 41-0, Fax: +49-(0) 77 33-94 41-20
E-Mail: info@rollwalztechnik.de, Web: www.rollwalztechnik.de

